

## Robust series Battery Chargers

### Installation and User Manual



# Table of Contents

Safety Instructions .....	3
Installation .....	4
Charging configuration.....	6
Operation .....	7
Indicators .....	8
Troubleshooting and repair.....	11
FCC/IC-information for optional radio module .....	12

## General

Powerfinn Robust series chargers use modern switching technology. The intelligent microcontroller extends the battery life by supervising the charging process. The charger is compact, silent and meets the EU safety and EMC requirements.

For hardware specification, see separate document "Specification".  
For detailed technical information, see "Robust technical handbook".

This document applies to typical hardware versions. Special HW versions for specific applications are not documented in this manual. This document applies to standard software type 11613002 revision 5 and later, upto revision 9, if not otherwise stated. Special SW types for specific applications are not documented in this manual.

Information is subject to change without notice.

### Guarantee

The charger has a guarantee of two years from the date of purchase. Guarantee covers manufacturing and component failures and is valid only if the equipment is installed and used according to the instructions in this manual.

Keep the receipt as evidence of the date of purchase.

# Safety Instructions

In addition to the safety measures mentioned in chapter 'Operations', the following personal precautions should be taken whenever charging batteries.

1. For emergency situations ensure in advance that help is available in time of need.
2. Batteries contain acid that is harmful to the eyes, skin and clothes. Always wear overalls and safety goggles. Never touch the eyes with unwashed hands after handling batteries.
3. Ensure that a working, fresh water tap is available. If acid gets into the eyes or on the skin, immediately rinse the area with plenty of water for several minutes. If visible injury occurs, contact a physician immediately. In case of eye injuries, always contact a physician.
4. The charging process generates explosive hydrogen gas. Do not smoke or otherwise bring burning or sparking matter to the vicinity of the battery when it is being charged.
5. If a short circuit occurs, the battery may explode or the item causing the short circuit may melt. Keep the work area clear from tools and debris. Remove jewelry, watches, etc. before working with the battery.
6. The power cord should be unplugged and the battery must be disconnected from the charger in case the equipment is left unused for a longer period of time.
7. The charger must be located away from heat sources like radiators and heat registers, radiation sources, hazardous gases (ozone) and high pressure vessels.
8. This device is not meant to be used by children or people whose physical, sensory or mental attributes or lack of experience and knowledge prevent them from using the device safely unless a person responsible for their safety supervises them or has instructed them how to use the device.

# Installation



Charger labeled with this symbol should be installed indoors in a low humid area.

These instructions apply to all types of chargers produced at the time of writing; types prefixed with "R" and "NSR".

The following points must be respected when installing the charger.

1. In fixed installation the operation temperature range is  $-35^{\circ}\text{C}$  to  $+55^{\circ}$ . Higher than  $+40^{\circ}$  ambient temperature will limit the output power.
2. The charging process generates explosive hydrogen gas. Install the charger as far away from the battery as possible to prevent hydrogen gases from entering the charger. Keep the space well ventilated. Never use an open flame or equipment that produces sparks close to the battery or charger.
3. For unplugging the unit, make sure the wall socket is located in an easy access area. Wall socket must provide protective earth terminal.
4. Install on concrete or other non-combustible surface only.
5. To ensure sufficient cooling, do not cover the charger. Leave a free space of at least 10 cm around all sides. For passive cooled model, leave 50 cm free space above and below the charger. Passive cooled model is to be installed vertically, with cable entry downward. Fan cooled model can be installed also horizontally.

Chargers are manufactured in various protection classes. IP class is usually marked on the product label. If IP class is not marked, or it is IP20, charger should be installed into a dry environment. To maintain protection class, install IP54 models vertically, with cable entry downward. IP65 and IP66 models can be installed with free orientation.

Charger slides to mounting plate from above and can be secured using screws.

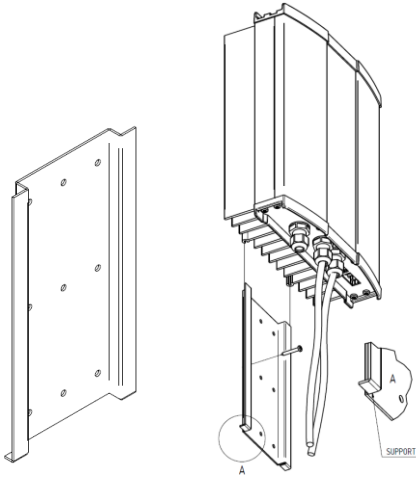

For fan cooled models, mounting plate is of different size but of similar type:

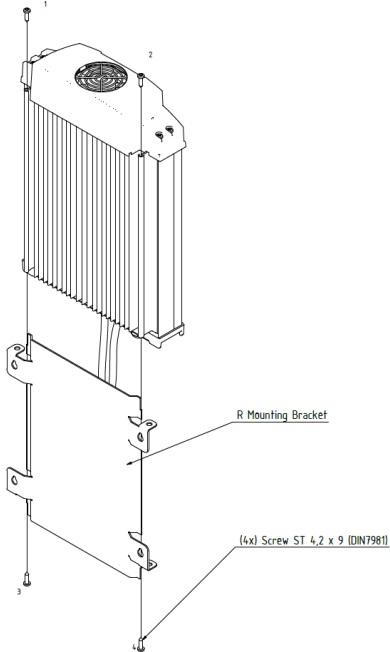

# Charging configuration

The charger voltage, charging algorithm and configured battery capacity should correspond to the battery parameters. Attempting to charge a battery with wrong charging configuration may result in considerable damage. For example, too large configured battery capacity results in excessive charging current. Do not attempt to charge non-rechargeable batteries. Charge lithium batteries only with appropriate BMS (Battery Management System).

When installing the charger, make sure that incompatible charger setups and batteries cannot be connected together. Connector arrangement is a reliable method. Matching battery type can be indicated by a label attached to the charger.

## Voltage and number of cells

Chargers are available for a variety of battery voltages. Robust series chargers can charge lead-acid batteries that have number of cells as follows:

charger type/ nominal voltage	number of cells in the battery	nominal voltage of the battery
1100/24, 2300/24, 3000/24	12	24
1100/36, 2300/36	18	36
1100/48, 2300/48, 3000/48	24	48

Also batteries with non-listed number of cells can be charged, if charger is properly configured. For more information on this, see Robust series technical handbook.

## Algorithm

Robust series chargers can charge freely ventilated and sealed lead-acid batteries. Verify compatibility of the algorithm and the battery with your battery manufacturer. For descriptions of algorithms, see Robust technical handbook, chapter "Algorithms".

For step-by-step instructions on how to select an algorithm using the front panel, see Robust technical handbook, chapter "Editing charging configuration".

## Capacity

Robust series chargers can charge lead-acid batteries that have nominal capacity between 50 ... 2000 Ah.

For step-by-step instructions on configuring the battery capacity using the front panel, see Robust technical handbook, chapter "Editing charging configuration".

# Operation

Read these operating instructions carefully before using the charger for the first time. Also read the chapter "Safety instructions" thoroughly. It must be ensured that children do not play with the device.

To charge a battery with "Robust" series charger, follow these instructions:

**The factory default setting is**

- **Algorithm LK10-06 freely ventilated lead-acid**

- **Battery capacity 50 Ah**

- **Number of cells is set according to nominal voltage of the charger. For example nominally 24 V charger is set to 12 cells.**

**To change the settings, see Robust technical handbook, chapter "Editing charging configuration".**

1. Ensure that the charger is unplugged and that the installation environment meets the conditions described in chapter "Installation".

**Warning: Explosive gases. Prevent flames and sparks. Provide adequate ventilation during charging.**

If charger has been stored in condensing or freezing temperature for an extended period, allow it to warm up and dry for 12 h before operating.

2. Connect the charger cables to the battery terminals: the positive (+) cable to the positive (+) terminal and the negative (-) cable to the negative (-) terminal. The positive cable is red colored. The negative cable is black or blue.

**Warning: Connection with wrong polarity might cause personal injuries and damage the charger and battery.**

3. Turn the power on by plugging the power cord in a mains outlet with protective earth.
4. Charging starts automatically.

## **STOP**

Pressing STOP will **PAUSE** charging. Pressing STOP again resumes charging.

## **F1 and F2**

F1 and F2 buttons can be assigned various functionality. By default no function is assigned, so pressing buttons during charging has no effect. Buttons are used when settings are changed. See chapter "Editing charging configuration" in Robust technical handbook.

5. To avoid sparking in output cables, press STOP button before disconnecting battery.

# Indicators

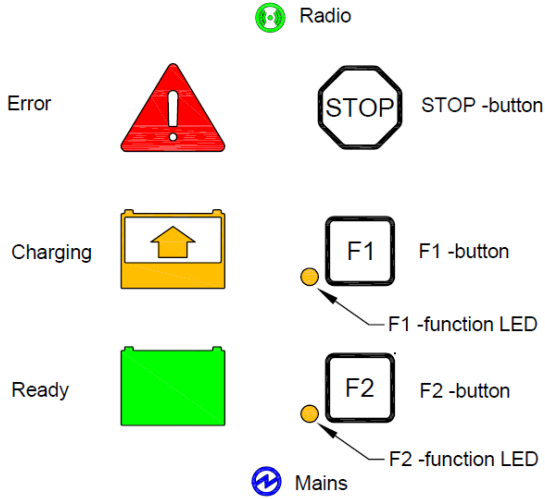

Mains is connected.













































Radio module is ON. Charger can be assembled with optional radio module. Module allows access to configuration and history log of the charger.





















Indicator definitions:

No light			
Continuous light			
Flashing			



Indications:

			Only blue mains indicator is lit. Charger is waiting for a battery to be connected.
			Green flashing: STOP pressed, charging paused
			Yellow continuously lit: main charging phase Defined in charging algorithm. Also power supply mode, power on.
			Additional charging. Defined in charging algorithm
			Equalize charging. Defined in charging algorithm
			Charging ready, maintenance charging. Defined in charging algorithm
			Charging restricted by remote input
			Alarm, no specific
			Alarm, low battery voltage. Defined in charging algorithm
			Alarm, high battery voltage. Defined in charging algorithm
			Alarm, time limit exceeded. Defined in charging algorithm
			Alarm, Ah limit exceeded. Defined in charging algorithm
			Alarm, invalid charging parameters
			Alarm, high charger temperature

			Alarm, low charger temperature or sensor fault
			Alarm, BMU init fail
			Alarm, regulation fault
			Alarm, radio gateway error
			Alarm, battery error
			Alarm, CAN timeout
			Alarm, CAN slave timeout

# Troubleshooting and repair

If the cause of malfunction cannot be found, contact your retailer or the manufacturer. If fuse is defective, charger has to be sent for control/repair. Only authorized persons can repair the charger.

## Determining operation mode

Charger has several operation modes; for example charger, SDO power supply and several remote controlled power supply modes. Operation mode is not directly indicated by front panel. Charger, SDO and PDO power supply mode can be read (and set) using front panel; see section "Editing charging configuration" in Robust technical handbook. Other modes can be read and set using CAN remote control; see Robust series technical handbook.

## Troubleshooting charger mode

Normal behaviour is as follows. Connect only AC input power cable. Only blue indicator should be lit after startup (and small green if optional radio module is installed). No voltage is present at power output. You can simulate battery with a single quadrant DC power supply (capable of positive voltage output vs. its ground). Power supply should be able to withstand counter voltage upto maximum output of the charger, which is  $1.5 \cdot$  nominal voltage. After some seconds of suitable voltage present at charger output, big yellow lits up and power output turns on. Since output is not loaded, output voltage jumps to maximum. Charger considers this as disconnected battery. Big yellow indicator and power output turn off. Capacitors maintain voltage for some time. Disconnect the DC power supply. Voltage at DC cables descends to zero in some seconds.

## Troubleshooting SDO power supply mode

Normal behaviour is as follows. Connect only AC input power cable. Big yellow indicator is lit after startup (in addition to small blue, also small green if optional radio module is installed). Check using voltage meter that voltage is output according to setting. Factory default settings are nominal voltage and maximum current. Voltage and current setting can be read using CAN bus or optional radio module. For more information on this, see Robust technical handbook or radio module documentation.

## Troubleshooting PDO and other remote controlled power supply modes

Normal behaviour is as follows. Connect only AC input power cable. Only blue indicator is lit after startup (and small green if optional radio module is installed). Activating power output usually requires sending CAN messages. See Robust technical handbook.

# FCC/IC-information for optional radio module

This product contains FCC ID: B7WACCESS, IC: 10687A-ACCESS.

-----WARNING!-----  
Changes/modifications not approved by the responsible party could void the user's authority to operate the equipment. This transmitter must not be relocated or operated in conjunction with any other antenna or transmitter. This equipment complies with FCC and IC radiation exposure limits set forth for an uncontrolled environment. This equipment should be installed and operated keeping the radiator at least 20cm or more away from person's body (excluding extremities: hands, wrists, feet and ankles).

-----AVERTISSEMENT!-----  
Les changements/modifications non approuvés par le parti responsable pourraient invalider l'autorité de l'utilisateur à faire fonctionner l'équipement. Cet émetteur ne doit pas être relocalisé ou être utilisé avec une autre antenne ou émetteur. Cet équipement est conforme aux limites d'exposition de émissions de IC, FCC réprésentées pour un environnement non contrôlé. Cet équipement devrait être installé de façon à ce que l'antenne soit éloigné de 20 centimètres ou plus du corps humain (en excluant les extrémités : les mains, les poignets, les pieds et les chevilles).